



Outperform every day.™

Project:
Item Number:
Quantity:

CAYENNE® PIZZA/BAKE OVEN



Cayenne® Pizza/Bake Oven

ITEMS

Item No.	Model No.	Description
40848	POA8002	Pizza Bake Oven

FEATURES

- Stainless steel exterior and interior for durability and easy cleaning
- Oven supplied with two ceramic bake decks for crisp, even browning of crust and breads
- Fifteen-minute timer function
- Heat setting: 140° - 750° F (60° to 400° C)
- 4 ft. (1.2 m) cord with plug

DESCRIPTION

Provide fresh baked pizzeria-style pizzas with this countertop version of a pizzeria deck oven. The even heat of the hearth stones and the higher temperature capability of this oven combine to make crisp, light, evenly-baked pizzas. Fresh hearth-baked pizzas create a distinct presentation and command a higher price than pizzas made in a countertop wire rack pizza oven.

WARRANTY

All models shown come with Vollrath's standard warranty against defects in materials and workmanship. For full warranty details, please refer to www.Vollrath.com.

Agency Listings



Due to continued product improvement, please consult www.vollrath.com for current product specifications.

Approvals	Date



Outperform every day.™

www.vollrath.com

The Vollrath Company, L.L.C.

1236 North 18th Street
Sheboygan, WI 53081-3201 U.S.A.
Main Tel: 800.624.2051 or 920.457.4851
Main Fax: 800.752.5620 or 920.459.6573
Customer Service: 800.628.0830
Canada Customer Service: 800.695.8560

Technical Services
techservicereps@vollrathco.com
Induction Products: 800.825.6036
Countertop Warming Products: 800.354.1970
All Other Products: 800.628.0832

CAYENNE® PIZZA/BAKE OVEN

DIMENSIONS (Shown in inches (cm))

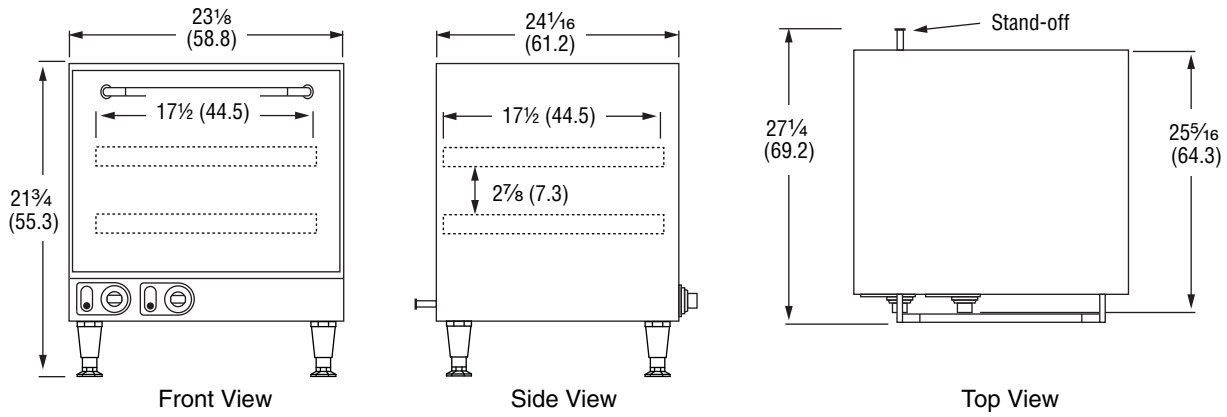

SPECIFICATIONS

Item No.	Cooking Chamber Size			Voltage	Watts	Amps	Plug
	Width	Depth	Height				
40848	$18\frac{1}{2}$ (47)	$19\frac{3}{16}$ (48.7)	$9\frac{7}{16}$ (23.9)	208-240	2100 - 2800	10.1-11.6	NEMA 6-15P

Receptacle

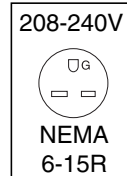

Outperform every day.™

www.vollrath.com

The Vollrath Company, L.L.C.

1236 North 18th Street
Sheboygan, WI 53081-3201 U.S.A.
Main Tel: 800.624.2051 or 920.457.4851
Main Fax: 800.752.5620 or 920.459.6573
Customer Service: 800.628.0830
Canada Customer Service: 800.695.8560

Technical Services
techservicereps@vollrathco.com
Induction Products: 800.825.6036
Countertop Warming Products: 800.354.1970
All Other Products: 800.628.0832