



HID540 - Ice Machine / Dispenser

Ice and Water Dispenser



Shown with optional KLP24A legs.

The Meridian™ Difference

- Smarter Construction - Durable stainless steel evaporator and exterior panels. Greaseless bearings for reduced maintenance. Larger sink opening and dispensing area. Antimicrobial AquaArmor with AgION™ is molded into key components.
- Space-maximizing design - The industry's smallest operational footprint relative to capacity. Featuring specially designed contoured sides for enhanced breathability and an external air filter.
- More convenient front access - Removable front panels allow ease of access and service to all key internal components. Including a removable storage bin for better cleaning and maintenance access.
- Enhanced service features - Intuitive LED diagnostic lights reduce service time. Unit specific QR code for quick access to service manuals and warranty history. Convenient USB drive that allows for fast software updates. New removable sink and grill provide maximum access for ease of cleaning.
- Energy and Water Efficiency - Industry leading efficiencies deliver on going savings.
- Quieter operation - Improved condenser fan function.



24 Hour Volume Production

Air Cooled			Water Cooled		
70°F/21°C 50°F/10°C	Air Water	90°F/32°C 70°F/21°C	70°F/21°C 50°F/10°C	Air Water	90°F/32°C 70°F/21°C
500/227 lb/kg		365/166 lb/kg	500/227 lb/kg		400/181 lb/kg



Specifications

Model Number	Condenser Unit	Storage Capacity	Basic Electrical Volts/Hz/Phase	Max. Fuse Size or HACR Circuit Breaker (amps)	Min. Circuit Amps	Energy Consumption kWh/100 lb 90°F(32°C)/70°F(21°C)	Water Usage Gallons/100 lb (liters/45.4 kg)	
							Potable 90°F(32°C)/70°F(21°C)	Condenser 90°F(32°C)/70°F(21°C)
HID540A-1	Air	40	115/60/1	15	Cord	5.5	12/45.5	-
HID540AW-1*	Air	40	115/60/1	15	Cord	5.5	12/45.5	-
HID540W-1	Water	40	115/60/1	15	Cord	4.3	12/45.5	120/454.3

*Wall mount configuration. Does not have or accept a drip tray. Unit designed to be installed over existing sink.



H²Nugget Ice

Chewable, slow-melting ice that allows for more reliable dispensing.



3/4" x 5/16" x 3/8"
(1.9 x 0.8 x 0.95 cm)



Certification



Warranty

- 3 years parts and labor.
- 5 years parts on the compressor and condenser.
- Warranty valid in North, South & Central America for commercial installations.
- Contact factory for warranty in other regions.
- Residential Applications: 1 year parts and labor



HID540 - Ice Machine / Dispenser

Ice and Water Dispenser

Without Wall Mount: HID540A & HID540W

Installation Note: Allow 6" space at left, back and right side for ventilation and utility connections.

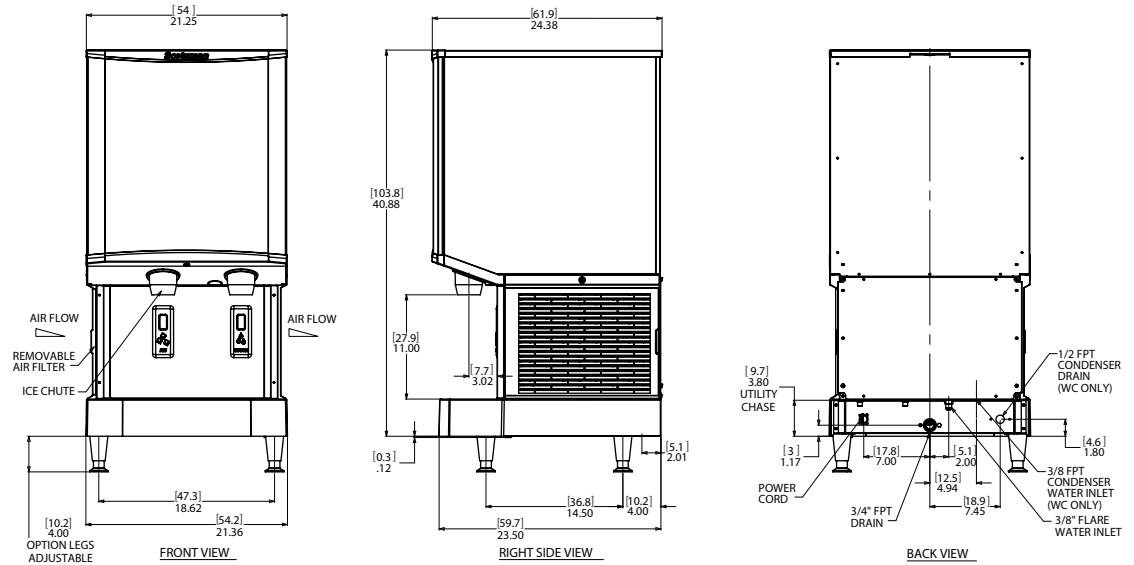

With Wall Mount: HID540AW

All models include 7.5' power cord with NEMA 5-15P plug

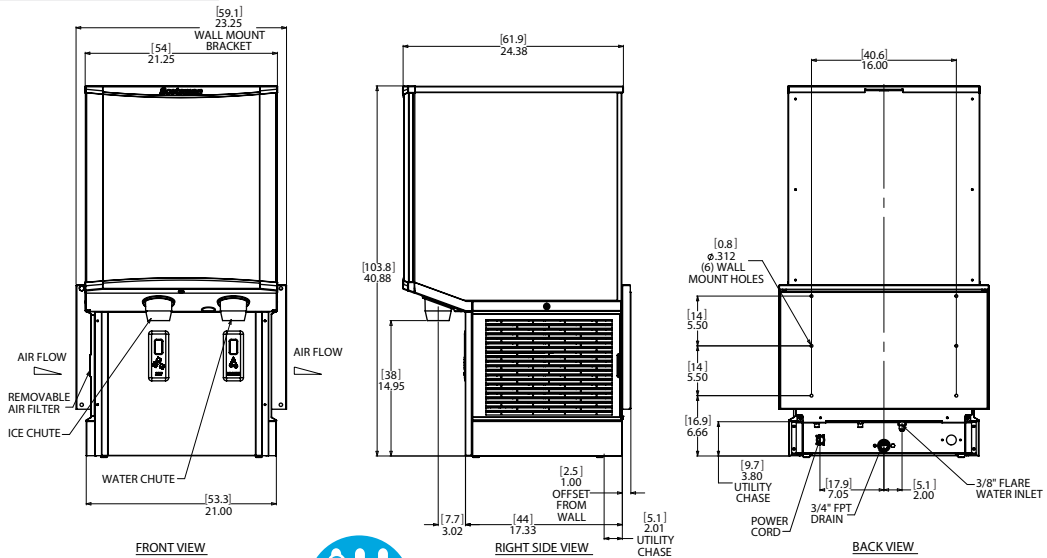

HID540 - Ice Machine / Dispenser



All Models

Dimensions (W x D x H):

Unit:	
HID540A-1:	21.25" x 24.38" x 41"
HID540AW-1:	23.25" x 24.38" x 41"
HID540W-1:	21.25" x 24.38" x 41"

Shipping Carton:

HID540A-1:	24.25" x 27.13" x 47.5"
HID540AW-1:	24.25" x 27.13" x 47.5"
HID540W-1:	24.25" x 27.13" x 47.5"

Shipping Weight:	HID540A-1: 215lb / 98kg
	HID540AW-1: 220lb / 100kg
	HID540W-1: 215lb / 98kg

BTUs per hour:	HID540A-1: 6,800
	HID540AW-1: 6,800

Refrigerant: R-404A



Accessories

Model Number Description

KLP24A	4" Adjustable legs, box of 4, plastic with metallic foot.
HST21-A	Machine stand for HID525 and HID540, with locking reversible door and shelf.
HST21B-A	Machine stand for HID525 and HID540, basic version.

Scotsman recommends all ice machines have water filtration. See Scotsman water filter specification sheet for details.



Operating Requirements

	Minimum	Maximum
Air Temperatures	50°F (10°C)	100°F (38°C)
Water Temperatures	40°F (4.4°C)	100°F (38°C)
Potable Water Pressures	20 PSIG (1.4 bar)	80 PSIG (5.5 bar)
Electrical Voltage	-5%	+10%

Specifications and design are subject to change without notice.

• 101 Corporate Woods Parkway, Vernon Hills, IL 60061 •

• 1-800-SCOTSMAN • Fax: 847-913-9844 • www.scotsman-ice.com • customer.relations@scotsman-ice.com •

© 2018 Scotsman Ice Systems.

Scotsman[®]

SIS-SS-MRD-HID540 02-18