



Super Runner Value Gas Fryers -- Domestic & Export

Project _____
 Item _____
 Quantity _____
 CSI Section 11400 _____
 Approval _____
 Date _____

Models

SR42G

SR52G

SR62G



SR62G
Shown with optional casters.

Standard Features

- Tube-type frypot design
- Oil capacity
 SR42G -- 43 lb. (21 liter)
 SR52G -- 50 lb. (25 liter)
 SR62G -- 75-lb. (37 liter)
- Btu/hr. input
SR42G -- 105,000 (26,481 kcal)
 (30.8 kw) (3-tube)
SR52G -- 120,000 (30,600 kcal)
 (35.2 kw) (4-tube)
SR62G -- 150,000 (37,783 kcal)
 (44 kw) (5-tube)
- Frying area
 SR42G 14" x 13-3/4" x 4-1/5" (35 x 34.9 x 10.7 cm)
 SR52G 14" x 14" x 3-1/2" (35 x 35 x 8.5 cm)
 SR62G 18" x 18" x 3-3/4" (46 x 46 x 9.5 cm)
- Durable temperature probe

- Millivolt control system - requires no electrical hookup
- Thermo-tube design
- Wide cold zone
- Stainless steel frypot, front, door, and backsplash/flue cover, aluminized sides
- Basket hanger
- 6" (15 cm) adjustable steel legs
- 3/4" (1.9 cm) NPT gas connection
- Basket support rack
- Two twin baskets

Options & Accessories

- Casters
- Frypot covers
- Natural and LP gas
- Full basket
- Triplet basket (SR62 only)

Specifications

Basic Frying At Its Best -- Designed For All-Purpose Usage

Fry a wide variety of products with Dean's Super Runner fryers which easily accommodate items from French fries to main entree menu selections. The fryers are available in three oil capacities utilizing 43 lbs., 50 lbs. and 75 lbs. of oil.

Make the most of your energy dollars with Dean's exclusive Thermo-Tube design. The heating tubes provide a large oil contact surface. Flow-tube baffles control the transfer of heat into the oil. Dean's wide cold zone frypot protects oil integrity by trapping debris under the cooking area, preventing carbonization of particles and wasteful oil deterioration.

Dean's durable temperature probe assures prompt recovery which reduces time lost between loads and requires no electrical hookup.

Dean's Super Runner gas fryers achieve dependability through simplicity of design, durable stainless steel baffles and rugged cast iron burners.



SR42 and SR62
Approved for
Australia

8700 Line Avenue
Shreveport, LA 71106
USA

Tel: 318-865-1711
Tel: 1-800-221-4583
Fax: 318-868-5987
E-mail: info@frymaster.com

www.frymaster.com
Bulletin No. 830-0117
Revised 1/15/15
Litho in U.S.A. ©Frymaster



Super Runner Value Gas Fryers -- Domestic & Export



Super Runner Value Gas Fryers -- Domestic & Export

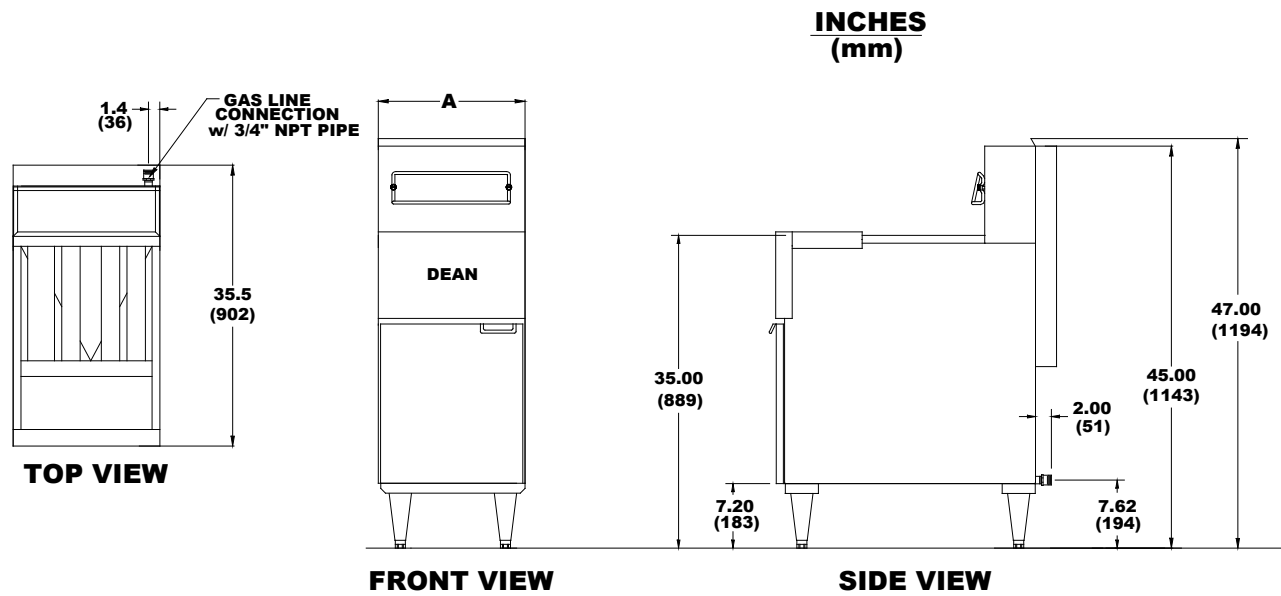

DIMENSIONS

MODEL	OIL CAPACITY	OVERALL SIZE (cm)			DRAIN VALVE HEIGHT (cm)	NO. OF TUBES	APPROXIMATE SHIPPING DIMENSIONS					
		WIDTH	DEPTH	HEIGHT			WEIGHT	CLASS	CU. FT.	DIMENSIONS (cm)		
SR42G	43 lbs. (21 liter)	15-1/2" (39.4)	29-1/4" (74.3)	45" (114.3)	18-3/8" (46.7)	3	150 (68 kg)	85	22	W 20-1/2" (52.1)	D 36" (91.4)	H 48-1/2" (123.2)
SR52G	50 lbs. (25 liter)	15-1/2" (39.4)	29-1/4" (74.3)	45" (114.3)	17-1/2" (44.5)	4	180 (82 kg)	85	22	20-1/2" (52.1)	36" (91.4)	48-1/2" (123.2)
SR62G	75 lbs. (37 liter)	20" (50.8)	35-1/2" (90.2)	45" (114.3)	19-3/4" (50.1)	5	255 (116 kg)	85	22	20-1/2" (52.1)	36" (91.4)	48-1/2" (123.2)

POWER REQUIREMENTS

MODEL	GAS CONNECTION	ELECTRICAL REQUIREMENT
SR42G	3/4" NPT	NONE
SR52G	Regulator not required for manifold pressure.	
SR62G	See note [*] .	

ORDERING DATA

Please specify:
 Natural or propane gas
 Altitude -- if between 2,000 - 6,000 ft. (610 - 1,829 Meters)

NOTE:

DO NOT CURB MOUNT.
^{*}SUPPLY PRESSURE: DO NOT EXCEED 14" W.C. or 1/2" PSI.
 No warranty for mobile kitchen applications.

HOW TO SPECIFY

The following description will assist with ordering the features desired for this equipment:

- SR42 43-lb (21-liter) tube-type gas fryer with millivolt controller and durable temperature probe
- SR52 50-lb (25-liter) tube-type gas fryer with millivolt controller and durable temperature probe
- SR62 75-lb (37-liter) tube-type gas fryer with millivolt controller and durable temperature probe

Model # _____
 CSI Section 11400

8700 Line Avenue
 Shreveport, LA 71106
 USA

Tel: 318-865-1711
 Tel: 1-800-221-4583
 Fax: 318-868-5987
 E-mail: info@frymaster.com

www.frymaster.com
 Bulletin No. 830-0117
 Revised 1/15/15
 Litho in U.S.A. ©Frymaster

