

**HOBART**701 S Ridge Avenue, Troy, OH 45374  
1-888-4HOBART • www.hobartcorp.com**LEGACY®  
HL1400 MIXER****HOBART****STANDARD FEATURES**

- Heavy-Duty 5 H.P. Motor
- Gear Transmission
- Four Fixed Speeds Plus Stir Speed
- Shift-on-the-Fly™ Controls
- Patented soft start Agitation Technology
- 50-Minute SmartTimer™
- Automatic Time Recall
- Large, Easy-To-Reach Controls
- Single Point Bowl Installation
- Ergonomic Swing-Out Bowl
- Power Bowl Lift
- Open Base
- Stainless Steel Bowl Guard
- Metallic Gray Hybrid Powder Coat Finish

**ACCESSORY PACKAGE - featuring  
Hobart Quick Release™ Agitators**

- **Standard Accessory Package Includes:**
  - 140 Quart Stainless Steel Bowl
  - 140 Quart "B" Beater
  - 140 Quart "ED" Dough Hook
  - 140 Quart Bowl Truck

**MODELS**

- HL1400 – 140-Quart All Purpose Mixer
- HL1400C – 140-Quart All Purpose Mixer with  
Maximum Security Correctional  
Package

Specifications, Details and Dimensions on Inside and Back.

**LEGACY® HL1400 MIXER**

# LEGACY® HL1400 MIXER



701 S Ridge Avenue, Troy, OH 45374  
1-888-4HOBART • www.hobartcorp.com

## SOLUTIONS/BENEFITS

### 5 H.P. Motor

Durability

- Heavy-duty to meet the most demanding operations

### Gear Transmission

Durability, Reliability

- Ensures consistent performance and minimum downtime under heavy loads

### Four Fixed Speeds plus Stir Speed

Flexibility, Reliability, Consistency

- For incorporating, blending, mixing ingredients
- Supports consistent results and thorough mixing

### Shift-on-the-Fly™ Controls

Flexibility

- Allows operator to change speeds while mixer is running

### Patented soft start Agitation Technology

Sanitation

- Each speed has a soft transition into a higher speed to reduce the chances of product splash-out

### 50-Minute SmartTimer™

Convenience, Ease of Use, Consistency

- Supports recipe mixing times
- Provides accurate results and eliminates overmixing

### Automatic Time Recall

Productivity, Consistency

- Remembers the last time set for each speed
- Great for multiple batches

### Ergonomic Swing-Out Bowl

Ease of Use, Convenience

- Easy loading and unloading of products
- Single Point Bowl Installation allows for simple mounting and removal of bowl
- Bowl Lock ensures mixer bowl is properly in place for mixer to operate

### Stainless Steel Bowl Guard

Protection

- Interlock prevents operation when front portion of guard is out of position

### Hobart Accessories

Durability, Flexibility, Simplicity

- Hobart Quick Release™ agitators allow for simple installation and removal from agitator shaft
- Hobart accessories are designed for long-term usage under heavy-duty conditions
- Large array of accessories provide multiple uses for recipe and product processing

## HL1400 MIXER CAPACITY CHART

Recommended Maximum Capacities - dough capacities based on 70°F. water and 12% flour moisture.

PRODUCT	AGITATORS SUITABLE FOR OPERATION	HL1400
CAPACITY OF BOWL (QTS. LIQUID)		140
Egg Whites	D	4 qts.
Mashed Potatoes	B & C	100 lbs.
Mayonnaise (Qts. of Oil)	B or C or D	50 qts.
Meringue (Qts. of Water)	D	5 qts.
Waffle or Hot Cake Batter	B	—
Whipped Cream	D or C	30 qts.
Cake, Angel Food (8-10 oz. cake)	C or I	120
Cake, Box or Slab	B or C	185 lbs.
Cake, Cup	B or C	165 lbs.
Cake, Layer	B or C	165 lbs.
Cake, Pound	B	185 lbs.
Cake, Short (Sponge)	C or I	150 lbs.
Cake, Sponge	C or I	140 lbs.
Cookies, Sugar	B	100 lbs.
Dough, Bread or Roll (Lt.-Med.) 60% AR	§ ED	210 lbs.*
Dough, Heavy Bread 55% AR	§ ED	175 lbs.*
Dough Pie	B & P	125 lbs.
Dough, Thin Pizza 40% AR (max. mix time 5 min.)	§‡ ED	135 lbs.□
Dough, Med. Pizza 50% AR	§‡ ED	190 lbs.□
Dough, Thick Pizza 60% AR	§‡ ED	190 lbs.*
Dough, Raised Donut 65% AR	ED	100 lbs.†
Dough, Whole Wheat 70% AR	ED	185 lbs.*
Eggs & Sugar for Sponge Cake	B & C or I	75 lbs.
Icing, Fondant	B	100 lbs.
Icing, Marshmallow	C or I	20 lbs.
Shortening & Sugar, Creamed	B	120 lbs.
Pasta, Basic Egg Noodle (max. mix time 5 min.)	ED	100 lbs.*

NOTE: % AR (% Absorption Ratio) - Water weight divided by flour weight. Capacity depends on moisture content of dough. Above capacities based on 12% flour moisture at 70°F water temperature.

□ 1st Speed

\* 2nd Speed

† 3rd Speed

§ If high gluten flour is used, reduce above dough batch size by 10%.

‡ 2nd Speed should never be used on 50% AR or lower products.

**USE OF ICE REQUIRES A 10% REDUCTION IN BATCH SIZE.**

**1 gallon of water weighs 8.33 lbs.**



701 S Ridge Avenue, Troy, OH 45374  
1-888-4HOBART • www.hobartcorp.com

# LEGACY® HL1400 MIXER

## SPECIFICATIONS

### MOTOR:

5 H.P. high torque motor.

200-240/50/60/3	14.8 Amps
380-460/50/60/3	6.8 Amps

### ELECTRICAL:

200-240/50/60/3 and 380-460/50/60/3 – UL Listed.

### CONTROLS:

Magnetic contactor with thermal overload protection. Internally sealed “Start-Stop” and Power Bowl Lift push buttons. Reduced voltage pilot circuit transformer is supplied for 380-460/50/60/3 machines. A 50-minute SmartTimer™ is standard. SmartTimer™ includes **Automatic Time Recall**, which remembers the last time set for each speed.

### TRANSMISSION:

A rated 10 H.P. poly-V belt transfers power from motor to the input shaft then geared down to desired reduction with a constant gear mesh. Gears and shafts are heat-treated hardened alloy steel along with anti-friction ball bearings. Circulating oil and grease lubricants furnished to all gears and shafts.

### SPEEDS:

	Agitator (RPM)
Stir	23
First	46
Second	80
Third	150
Fourth	265

### BOWL GUARD:

Heavy-duty stainless steel wire front and solid stainless steel rear portion. Front portion of guard rotates easily to add ingredients and install or remove agitator. It detaches in seconds for cleaning in dishwasher or sink. Rear portion of guard can be quickly cleaned in position. Guard must be in closed position before mixer will operate. Bowl support interlock provides further protection.

### POWER BOWL LIFT:

Powered by an electric motor, the bowl may be raised or lowered by fingertip control through the conveniently located switch. Bowl will remain in position until switch is activated. **Stir-on-Lift Feature:** Allows the agitator to run in Stir Speed while the mixer bowl is being raised. Once the bowl is in the raised position, the mixer automatically shifts into the preselected speed.

### FINISH:

Metallic Gray Hybrid Powder Coat finish.

### FOOTPADS:

Neoprene footpads are standard.

### ATTACHMENTS AND ACCESSORIES:

The following are available at extra cost:

Stainless Steel Bowl	Bowl Extension Ring
“B” Flat Beater	Bowl Splash Cover
“C” Wing Whip	Bowl Scraper
“D” Wire Whip	Bowl Truck
“ED” Dough Hook	40, 60 & 80 Quart
“P” Pastry Knife	Accessories
“I” Heavy Duty Wire Whip	Ingredient Chute



Hobart Bowl Scraper

Hobart Ingredient Chute



**LISTED BY:** Underwriters Laboratories Inc. and NSF International.

# LEGACY® HL1400 MIXER



701 S Ridge Avenue, Troy, OH 45374  
1-888-4HOBART • www.hobartcorp.com

## SPECIFICATIONS

**ELECTRICAL SPECIFICATIONS:** 200-240/50/60/3,  
380-460/50/60/3 – UL Listed.

**WEIGHT:** 1,385 lbs. net; 1,417 lbs. domestic shipping.

**WARRANTY:** Unit has full one-year warranty on parts, labor and mileage against manufacturer's defects. Service contracts are available.

## DETAILS AND DIMENSIONS

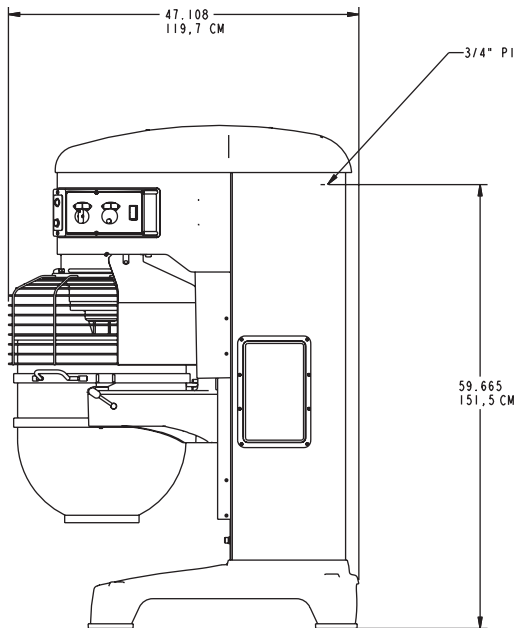
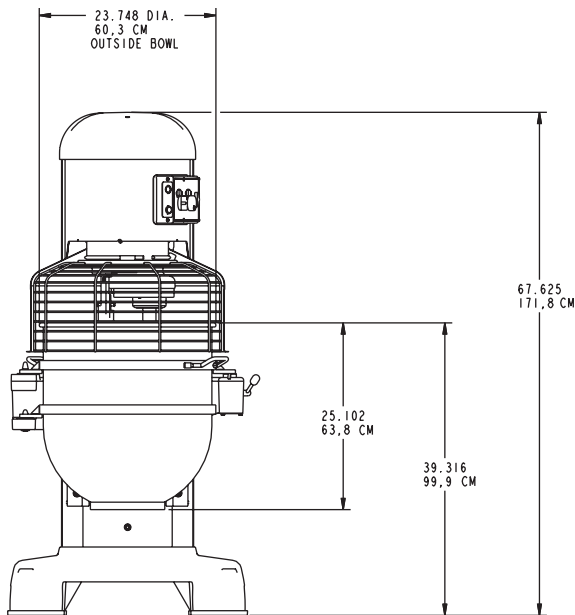

### WARNING

ELECTRICAL AND GROUNDING CONNECTIONS MUST COMPLY WITH THE APPLICABLE PORTIONS OF THE NATIONAL ELECTRICAL CODE AND/OR OTHER ELECTRICAL CODES.

STANDARD MODEL:  
NET WEIGHT (BOWL INCLUDED) 1460 LBS (662 KG)  
BOWL WT 74.6 LBS (33.8 KG) - REF

LEGEND:  
E1- ELECTRICAL CONNECTION

NOTE: UNIT MUST BE BOLTED TO LEVEL FLOOR.

MACHINE ELECTRICAL SPECS:  
400V., 50 HZ., 3 PH., 6.8 AMPS

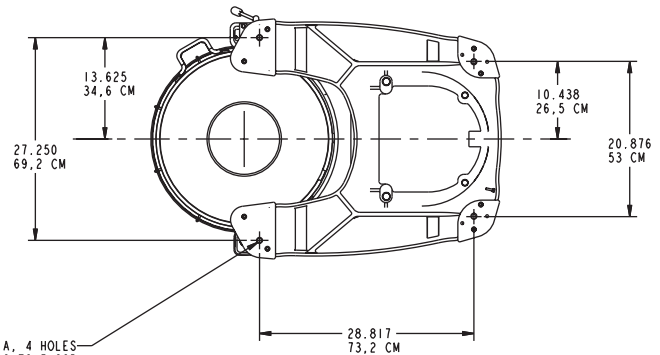

5/8 DIA., 4 HOLES FOR BOLTING TO FLOOR (MUST BE BOLTED TO LEVEL FLOOR)

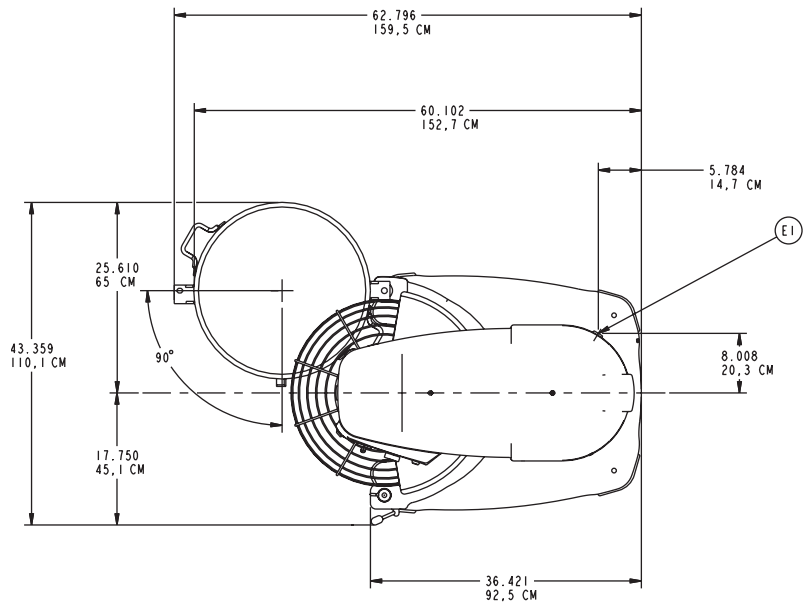

As continued product improvement is a policy of Hobart, specifications are subject to change without notice.