

Ice Dispenser: storage capacity up to 59 Kg



Features

- Stores up to 59 Kg (120 lbs.) of cube ice.
- Simple "Push" ice chute activates ice dispensing mechanism.
- Modern, stylish design in a stainless steel cabinet.
- Removable top panel allows easy access to the bin for routine cleaning
- Improved drip tray depth will accommodate most sizes of hotel ice buckets.
- Equipped with a 3 mt (11 ft.) power cord.
- Match the IceValet® dispenser with a Scotsman Prodigy®, MV, MC, MFN ice machine. Self-monitoring technology, cost-saving energy efficiency, extended time between cleanings, easy-access servicing and built-in anti-microbial protection: these features add up to the smartest choice in ice making and dispensing technology.

Polyurethane Insulation

Foam insulation is forced between the dispenser stainless steel panels and liner under heat and pressure to form a perfect "wall-to-wall" bond, preserving ice supply for longer periods.



Easy Push Chute

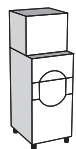

HD22+MV306
(sold separately)

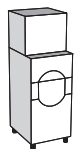

HD22+MV426
(sold separately)

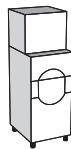

HD22+C322
(sold separately)

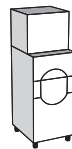

HD22+C522
(sold separately)

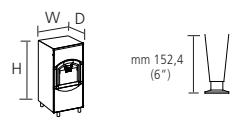
	 DICE CUBE			
	[kg]	[lbs]	N°*	
HD 22	59	120	5900	[WxDxH mm] 558x850x1351
*Estimated number of Dice Cubes				[WxDxH inches] 22"x33 1/2"x53 1/4"

This product qualifies for the following listings:



Half Large Cube - 6 g
W 10 x D 24 x H 29 mm



Large Cube - 17 g
W 29 x D 24 x H 29 mm

Half Dice Cube - 6 g
W 11 x D 24 x H 22 mm



Dice Cube - 10 g
W 22 x D 24 x H 22 mm

2 Years Warranty

Subject to certain limitations and exclusions

Certified ISO 9001:2000

www.scotsman-ice.it
www.scotsman-ice.com
www.scotsman-ice-on-tablet.com

Models and specifications are subject to change without notice.

Ice Dispenser: storage capacity up to 59 Kg

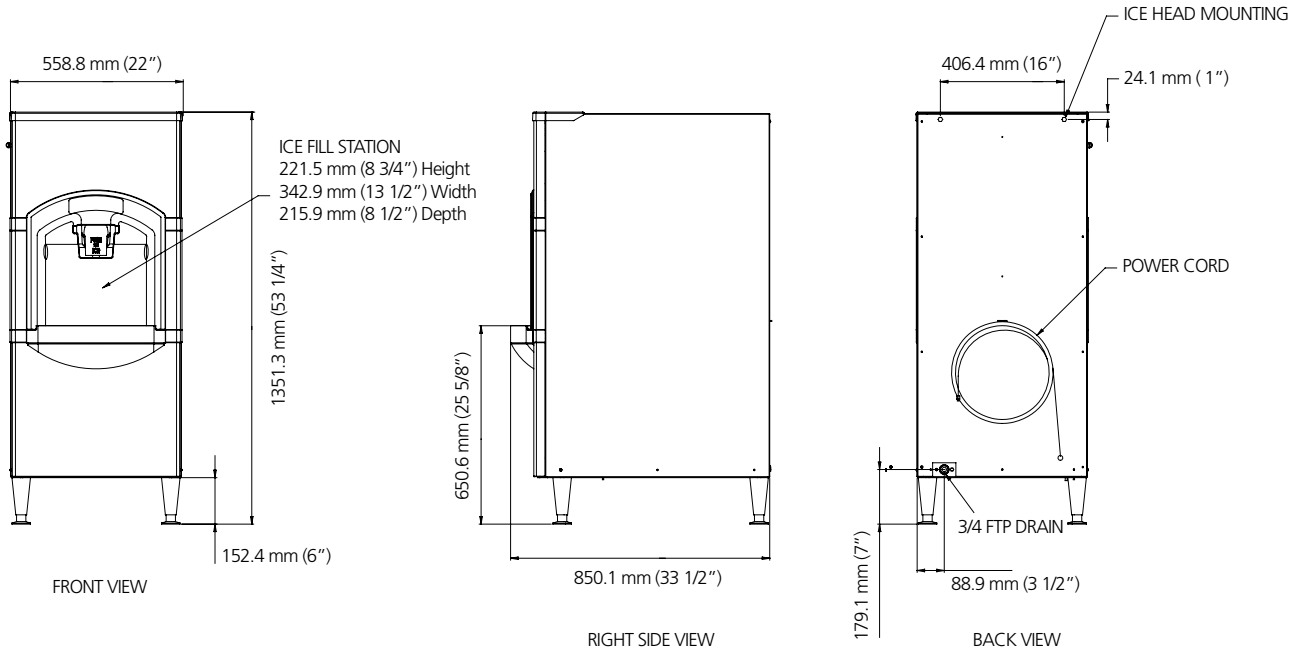

Minimum		Maximum
10°C (50°F)		40°C (104°F)
5°C (41°F)		35°C (95°F)
-10%		+10%
1 BAR 14 psi		5 BAR 70 psi

	 [Ømm²]	 FUSE	 [kg] [lbs]	 [lbs]
HD 22	-	15 A	84 185	199